

Holzworth has refined its multi-channel platform in the form of the HS9000 Series for integration of the HSM Series Single Channel Synthesizers. The HS9000 series is designed to achieve optimal channel-to-channel stability via a conductively cooled, fan-less enclosure, with specific attention to phase coherency between the independently controllable channels.



The HS9000 Series is a unique platform allowing the user to specify the configuration of a COTS product. Units are loaded with anywhere from 1 to 8 channels, with the additional flexibility to specify the frequency limit of each loaded channel. The result is a high performance, multi-channel synthesizer that is tailored to an application while optimizing the price point.

FULLY INDEPENDENT CHANNELS

No power dividers. Each RF output is driven by a separate, internally loaded synthesizer module. Up to 8 independently tunable synthesizers can be specified per 1U chassis allowing for the highest integrated channel density available in its class. With an average power dissipation of 7Watts per channel, the HS9000 series is highly efficient.

PHASE COHERENT CHANNELS

Holzworth Multi-channel RF Synthesizer modules offer the benefits of a proprietary NON-PLL based synthesis architecture. Coupling the NON-PLL architecture with a centralized reference distribution subsystem enables a truly phase coherent relationship across all integrated channels.

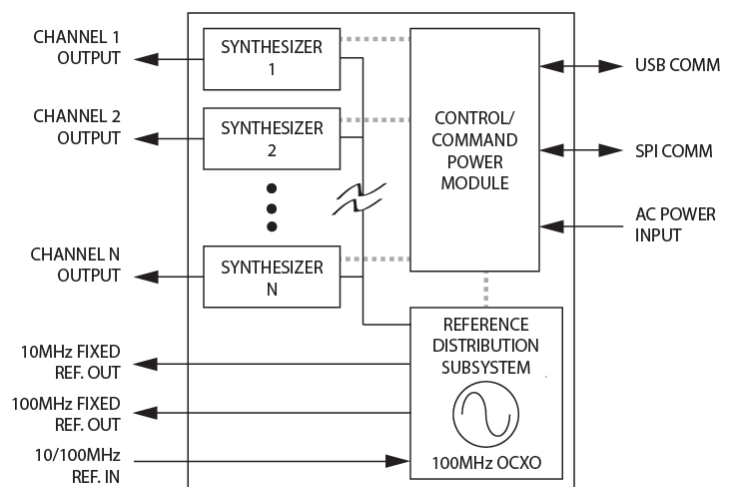

THE ULTIMATE IN CHANNEL-TO-CHANNEL STABILITY

Different from traditional PLL based synthesizers, Holzworth's proprietary architecture creates precisely synthesized signals that exhibit both instantaneous and long term stability. Temperature variations between the channels remain the only contribution to drift. The thermally optimized, fan-less chassis was specifically developed for maintaining the lowest possible thermal gradients from channel-to-channel.

Holzworth multi-channel designs are integrated into precision applications that range from particle accelerator timing clocks to satellite position tracking. Due to the necessity for ultimate stability, Holzworth synthesizers also come standard with thermal monitor outputs to track relative channel temperatures.

ELECTRICAL SPECIFICATIONS - FREQUENCY

The specified parameters for the HS9000 Series RF Synthesizers are fully verified at final performance test and 100% guaranteed for the warranted life of the product. Performance specifications listed on this page are specific to Frequency.

FREQUENCY PERFORMANCE¹

PARAMETER	MIN	TYPICAL	MAX	COMMENTS
Frequency Option Ranges OPT-A1 thru OPT-A8 OPT-B1 thru OPT-B8 OPT-C1 thru OPT-C8 OPT-D1 thru OPT-D8 OPT-E1 thru OPT-E8	250 kHz 250 kHz 250 kHz 250 kHz 250 kHz		1.024 GHz 2.048 GHz 3.072 GHz 4.096 GHz 6.720 GHz	All are settable to 100kHz
Frequency Resolution	0.001 Hz			
Phase Offset Resolution 250 kHz – 512 MHz 512 MHz – 1.024 GHz 1.024 GHz – 2.048 GHz 2.048 GHz – 4.096 GHz 4.096 GHz – 6.528 GHz		0.1 deg 0.2 deg 0.4 deg 0.8 deg 1.6 deg		Offset Accuracy: ±0.05 deg ±0.10 deg ±0.20 deg ±0.40 deg ±0.80 deg
Switching Speed (Frequency) SPI Mode (ASCII) SPI Mode (Binary) List/Step Sweep Mode (WB) List/Step Sweep Mode (NB)			300 µs 100 µs 100 µs 6 µs	Wideband Steps (full bandwidth) Narrowband Steps (<5% bandwidth)
Internal Time Base Reference (Oscillator Aging Rate)		□	± 1 ppm/yr	1 st year. ±0.5 ppm/yr each subsequent year
Temperature Effects		± 1 ppm		0 to 55 °C
Line Voltage Effects (12V)		± 0.1 ppm		• ±5%
Reference Output Frequency Amplitude Impedance	+2 dBm	100MHz 50 Ω	+6 dBm	Nominal Nominal
External Reference Input Input Frequency 10MHz Lock Range 10MHz External Amplitude 100MHz External Amplitude Impedance Waveform	0 dBm +2 dBm	10 / 100 ± 4 ppm 50 Ω	± 1 ppm +10 dBm +6 dBm	Software Select 10MHz, 100MHz or No Ext. Ref. 20Hz Locking BW, Internal OCXO remains on 20Hz Locking BW, Internal OCXO remains on Internal OCXO shuts off 50 Ω (nom) Sine
Digital Sweep Modes Operating Modes Sweep Range Dwell Time Number of Points (STEP) Number of Points (LIST) Triggering	250 kHz 100 µs 2 2		6.528 GHz 100 s 65535 3201	Step sweep (linear, internal) List Sweep (arbitrary list of freq steps) Simultaneous Amplitude sweep (list) 1 µs increments Free Run, External Trigger

¹ Specifications are subject to change per the discretion of Holzworth Instrumentation, Inc

ELECTRICAL SPECIFICATIONS - AMPLITUDE

The specified parameters for the HS9000 Series RF Synthesizers are fully verified at final performance test and 100% guaranteed for the warranted life of the product. Performance specifications listed on this page are specific to Amplitude.

AMPLITUDE PERFORMANCE¹

PARAMETER	MIN	TYPICAL	MAX	COMMENTS
Output Power (Calibrated)	-80 dBm		+10 dBm	Settable to +13dBm
Resolution			0.01 dB	
Step Attenuator	0 dB		100 dB	5 dB steps
Connector		50 Ω		SMA
SWR				
<100 MHz		1.7:1		
< 2.048 GHz		1.4:1		
< 3.072 GHz		1.5:1		
< 6.528 GHz		2.0:1		
Maximum Reverse Power				
Max DC Voltage			25 VDC	
250 kHz to 6.528 GHz			10 mW	10dBm
Switching Speed (Amplitude)				
SPI Mode			300 μ s	
List / Step Sweep Mode			100 μ s	Settling to within 0.1 dB
Absolute Level Accuracy				
>+10dBm		+0.15 /-0.5 dB	+0.5 /-1.0dB	
+10 to -30dBm		\pm 0.15 dB	\pm 0.5 dB	
-30 to -70dBm (<4GHz)		\pm 0.25 dB	\pm 0.8 dB	
-30 to -60dBm (>4GHz)		\pm 0.25 dB	\pm 0.8 dB	25C to 35C (case temperature)
SSB Phase Noise				
100 MHz, 10kHz offset		\leq -150 dBc/Hz		\leq -151 dBc/Hz @ 20kHz offset
500 MHz, 10kHz offset		\leq -139 dBc/Hz		\leq -140 dBc/Hz @ 20kHz offset
1.0 GHz, 10kHz offset		\leq -134 dBc/Hz		\leq -135 dBc/Hz @ 20kHz offset
2.0 GHz, 10kHz offset		\leq -128 dBc/Hz		\leq -129 dBc/Hz @ 20kHz offset
3.0 GHz, 10kHz offset		\leq -123 dBc/Hz		\leq -124 dBc/Hz @ 20kHz offset
4.0 GHz, 10kHz offset		\leq -122 dBc/Hz		\leq -123 dBc/Hz @ 20kHz offset
6.0 GHz, 10kHz offset		\leq -118 dBc/Hz		\leq -119 dBc/Hz @ 20kHz offset
Harmonics (CW mode)				
Pout = 0dBm		-40 dBc	-30 dBc	
Pout = +10dBm		-30 dBc	-20 dBc	
Non-Harmonics (CW mode)				
250 kHz to 3.072 GHz		-70 dBc	-60 dBc	
3.072 GHz to 6.528 GHz		-60 dBc	-50 dBc	
Sub-Harmonics (CW mode)				
250 kHz to 3.072 GHz		-70 dBc	-60 dBc	
3.072 GHz to 6.528 GHz		-60 dBc	-50dBc	
Jitter				
155 MHz		60 fs		100Hz < BW < 1.5MHz
622 MHz		61 fs		1kHz < BW < 5MHz
2.488 GHz		55 fs		5kHz < BW < 20MHz

¹ Specifications are subject to change per the discretion of Holzworth Instrumentation, Inc

ELECTRICAL SPECIFICATIONS - MODULATION (External Stimulus)

The external stimulus modulation parameters are only available on units equipped with option OPT-EXTMOD. Units with OPT-EXTMOD have channel dedicated modulation input ports installed. Internal "self modulation" functions are to be specified.

PARAMETER	PERFORMANCE	COMMENTS
FREQUENCY MODULATION¹ (Analog)		
Max Deviation	100 kHz	
Resolution	0.01% or 1mHz, whichever is greater	
Deviation Accuracy	< ± 2%	
Modulation Freq. Response	DC to 20 kHz (-3dB)	DC Coupled
Distortion	TBD	
Sensitivity when using Ext. Input	± 1V peak into 50Ω	+ 1V: Maximum Positive Deviation 0V: Zero Deviation from Carrier - 1V: Maximum Negative Deviation
PHASE MODULATION¹ (Analog)		
Modulation Deviation	±1.6 deg to ±180 deg	
Frequency Response	DC to 20 kHz (-3dB)	DC Coupled
Resolution	Frequency Dependent	See Phase Offset Specification
Distortion	TBD	
Sensitivity when using Ext. Input	± 1V peak into 50Ω	+ 1V: Maximum Positive Deviation 0V: Zero Deviation from Carrier - 1V: Maximum Negative Deviation
AMPLITUDE MODULATION¹ (Analog)		
AM Depth Type	Linear	
Depth		
Maximum	5% to 75%	0.45 dB to 12 dB
Resolution	<3% of Maximum Depth	
Depth Accuracy	5% of Maximum Depth	
Modulation Rate	DC to 10 kHz (-3dB)	DC Coupled
Distortion	TBD	
Sensitivity when using Ext. Input	± 1V peak for indicated Depth (into 50Ω)	+ 1V: Maximum Amplitude 0V: 50% of Maximum Depth - 1V: Maximum Depth
PULSE MODULATION¹ (Analog)		
Risetime (T _r)	<100 ns	
Falltime (T _f)	<100 ns	
On/Off Ratio	> 70dB	
Minimum Pulse Width	200 ns	
ALC Loop Deviation (Open Loop) ²	1dB ²	

¹ Specifications are subject to change per the discretion of Holzworth Instrumentation, Inc

² ALC Loop is disabled during pulse modulation

PARAMETER	PERFORMANCE	COMMENTS
External Trigger Threshold	+1.2V	±5% into 50Ω

ENVIRONMENTAL SPECIFICATIONS ¹

Environmental specifications are based on component margins, thermal verification testing and current draw tests.

PARAMETER	MIN	TYPICAL	MAX	COMMENTS
Operating Temperature	0 C		+55 C	
Temperature Monitor Range	-40 C		+85 C	Absolute, channel dedicated outputs
AC Power Supply	100 VAC		240 VAC	50 – 60Hz
Power Consumption Single Channel		12W		5W + 7W per Channel
4 Channel		25W		
8 Channel		50W		
Warm-Up Time		10 min	20 min	20 C (ambient temp. dependent)

¹ Specifications are subject to change per the discretion of Holzworth Instrumentation, Inc

PHASE DRIFT PERFORMANCE

Holzworth non-PLL based multi-channel RF synthesizers provide superior channel-to-channel phase coherency. The unique architecture also leverages a channel-to-channel phase drift advantage over other synthesis solutions. Figures 1a and 1b demonstrate channel-to-channel phase drift over a 1 hour period under ambient laboratory conditions (20C ±2C).

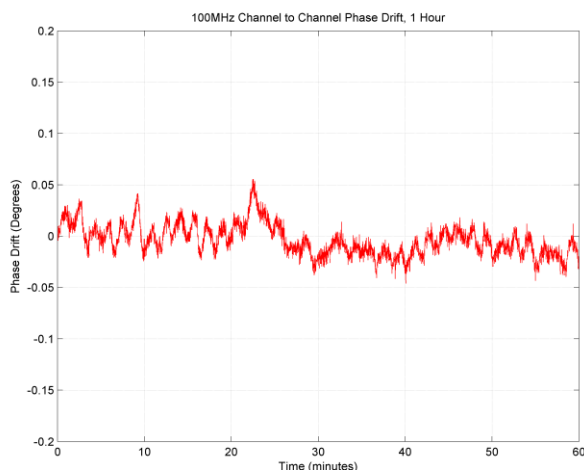

Figure 1a: 100MHz Phase Drift (1hr, 20C)

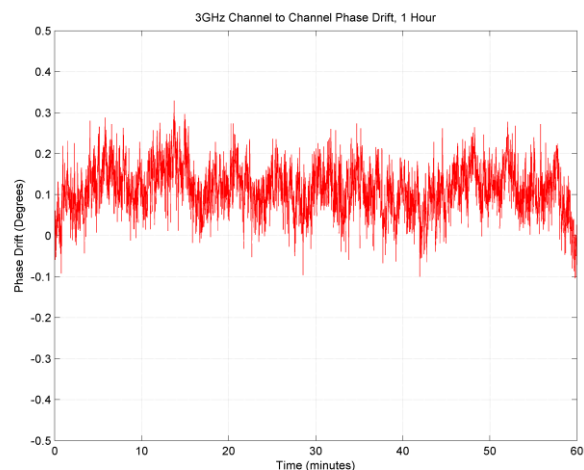

Figure 1b: 3GHz Phase Drift (1hr, 20C)

PHASE NOISE

Holzworth products are well known for their ultra low phase noise characteristics. All products undergo 100% phase noise performance verification prior to shipment.

SYNTHESIZER CHANNEL PERFORMANCE

The raw data displayed in Figure 2 is of SSB Phase Noise vs. Frequency Offset as measured for the HSM Series RF Synthesizer Modules. All data was collected with output power set at +10dBm.

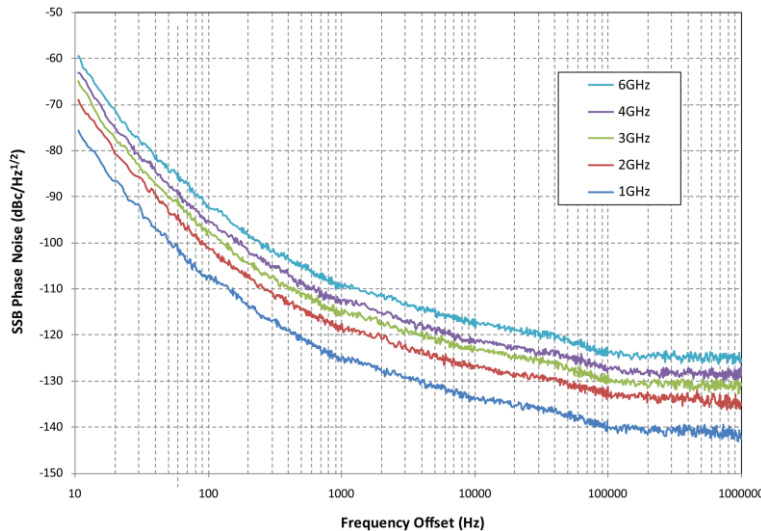

Figure 2: Channel SSB Phase Noise (P_{OUT}=+10dBm)

FIXED REFERENCE OUTPUT PERFORMANCE

The HS9000 Series come equipped with fixed 10MHz and 100MHz reference outputs. The fixed reference output signals are derived directly from the internal OCXO, exhibiting phase noise performance that is approximately 10dB better than the synthesized equivalent.

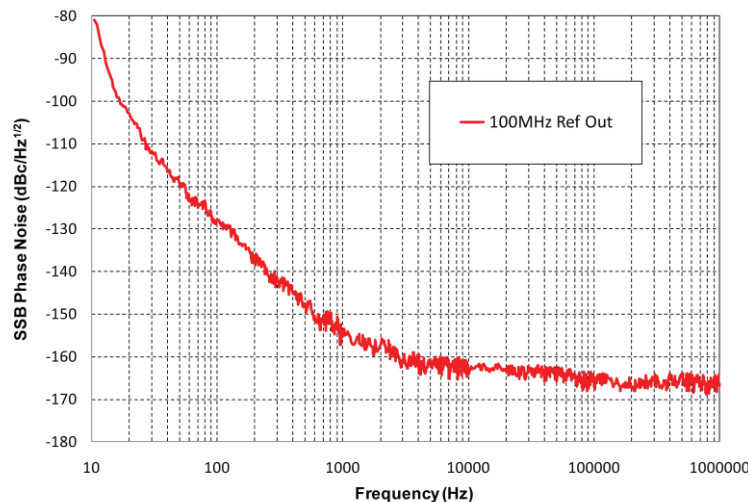

Figure 3: Reference SSB Phase Noise (+4dBm)

SPECTRAL PURITY DATA

The data contained in this section demonstrates the spectral purity performance of the HS9000 Series designs. All measurements are made at $P_{out} = +10\text{dBm}$ to demonstrate worst case performance. Spectrum analyzer test settings: 100kHz Resolution BW, 10kHz Video BW.

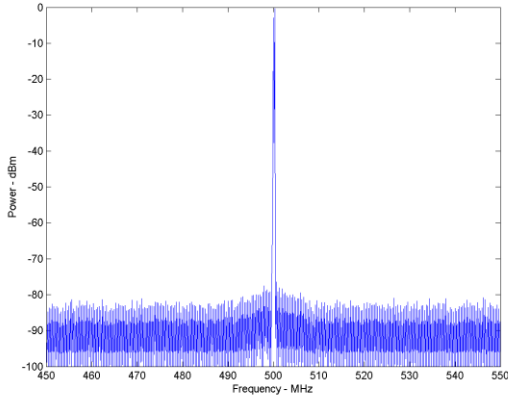

Figure 4a: 500MHz Narrow Band Spectrum

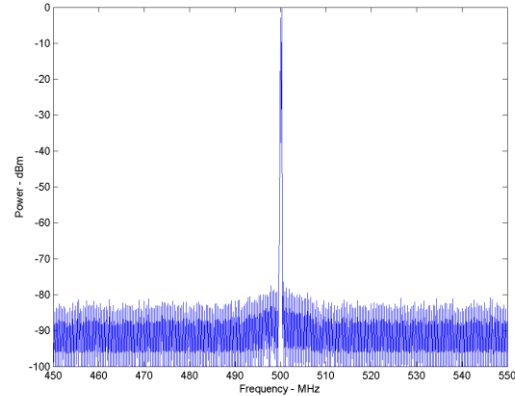

Figure 4b: 500MHz Broad Band Spectrum

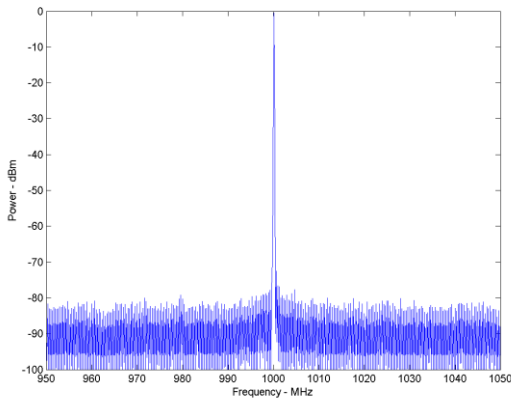

Figure 5a: 1GHz Narrow Band Spectrum

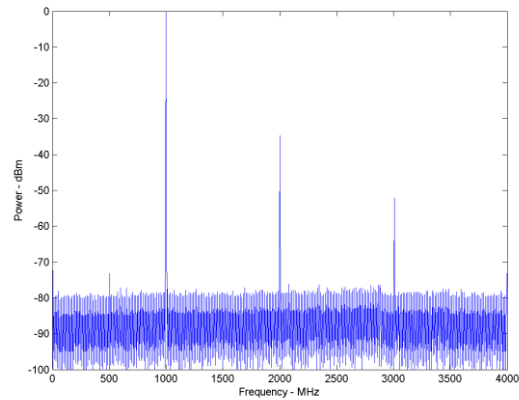

Figure 5b: 1GHz Broad Band Spectrum

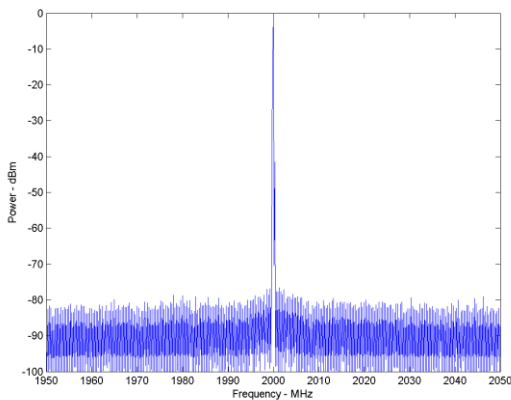

Figure 6a: 2GHz Narrow Band Spectrum

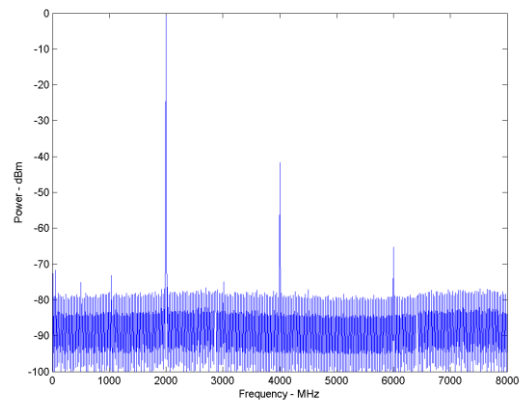

Figure 6b: 2GHz Broad Band Spectrum

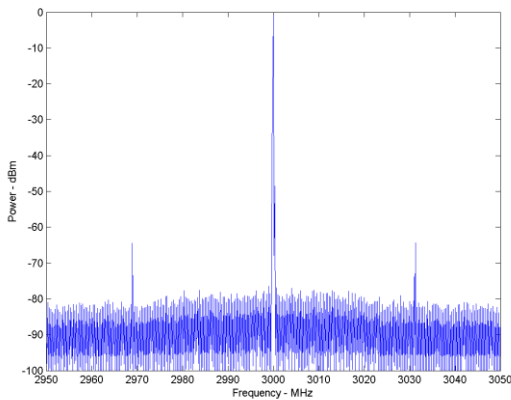

Figure 7a: 3GHz Narrow Band Spectrum

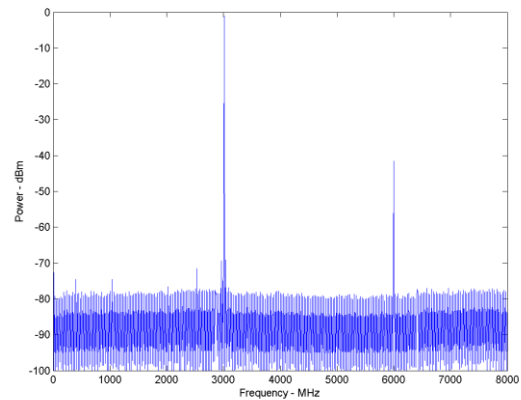

Figure 7b: 3GHz Broad Band Spectrum

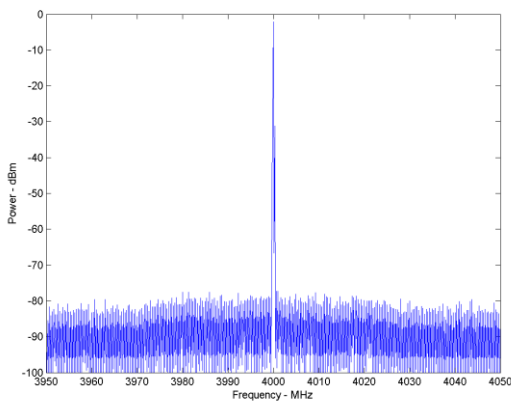

Figure 8a: 4GHz Narrow Band Spectrum

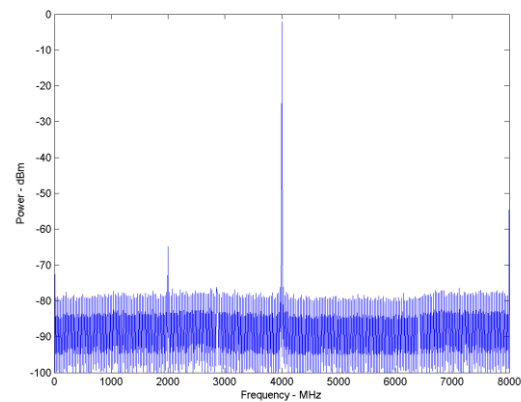

Figure 8b: 4GHz Broad Band Spectrum

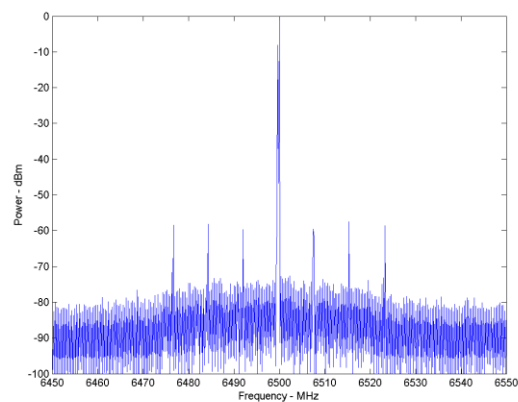

Figure 9a: 6.5GHz Narrow Band Spectrum

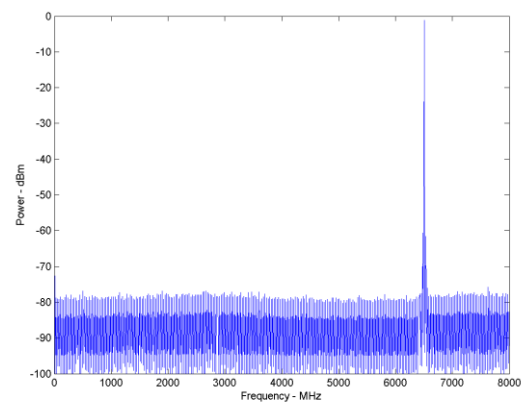

Figure 9b: 6.5GHz Broad Band Spectrum

Data at additional frequencies available upon request.

HS9000 SERIES CONFIGURATION GUIDE

The HS9000 Series synthesizer platform is designed to be user/application defined. Follow 4 easy steps to determine the part number with the required options. **A legacy part number cross reference matrix is located on page 12 of this document.**

STEP 1: SELECT TOTAL NUMBER OF CHANNELS

Select the base part number, strictly calling out the total number of channels to be loaded into the multi-channel chassis.

No. Channels	1	2	3	4	5	6	7	8
Part Number	HS9001A	HS9002A	HS9003A	HS9004A	HS9005A	HS9006A	HS9007A	HS9008A

STEP 2: SELECT CHANNEL FREQUENCY OPTIONS

Select any combination of channel frequency options. Note that the total number of channels specified here must equal the number of channels selected under STEP 1.

Frequency Range	Number of Channels per Frequency Range							
	1x	2x	3x	4x	5x	6x	7x	8x
250kHz to 1GHz	OPT-A1	OPT-A2	OPT-A3	OPT-A4	OPT-A5	OPT-A6	OPT-A7	OPT-A8
250kHz to 2GHz	OPT-B1	OPT-B2	OPT-B3	OPT-B4	OPT-B5	OPT-B6	OPT-B7	OPT-B8
250kHz to 3GHz	OPT-C1	OPT-C2	OPT-C3	OPT-C4	OPT-C5	OPT-C6	OPT-C7	OPT-C8
250kHz to 4GHz	OPT-D1	OPT-D2	OPT-D3	OPT-D4	OPT-D5	OPT-D6	OPT-D7	OPT-D8
250kHz to 5GHz	OPT-E1	OPT-E2	OPT-E3	OPT-E4	OPT-E5	OPT-E6	OPT-E7	OPT-E8

STEP 3: SELECT ADDITIONAL OPTIONS

The options listed in this section are available for the multi-channel platform to comply with application specific requirements.

OPTION	Description
OPT-RACK	19" Rack Mount Bracket Kit for 1U chassis
OPT-OCXO	High Performance OCXO. 10dB Improved Phase Noise at close to the carrier
OPT-ALTREF	Rear panel reference input and outputs
OPT-PWR25	+25dBm maximum output power level (specify for up to 4 channels)
OPT-EXTMOD	Channel dedicated, external modulation input (specify for up to 4 channels)
OPT-INTGR	Enhanced base-10 frequency accuracy. DDS FTW rounding error correction
OPT-COMM	Custom communications configuration (GPIB, Ethernet, etc.)
OPT-FIRM	Custom firmware. Application specific routines

PART NUMBER EXAMPLE

Ordering a 7 channel synthesizer with 3x 3GHz channels, 4x 6.7GHz channels, and a high performance OCXO would result in the following configuration:

Part Number:	HS9007A	Description:	7 ch, Multi-Channel RF Synthesizer
Options:	OPT-C3		3x 3GHz Channels
	OPT-E4		4x 6.7GHz Channels
	OPT-OCXO		High Performance OCXO

MECHANICAL CONFIGURATION

Holzworth multi-channel RF Synthesizer modules are encased in a 1U high, reinforced housing. Connector quantities are dependent on loaded options. INCLUDED: 1x secure fit USB 2.0 cable (10ft/3m), and 1x AC power cord (6ft/1.8m) are included. Specify country code for power cord.

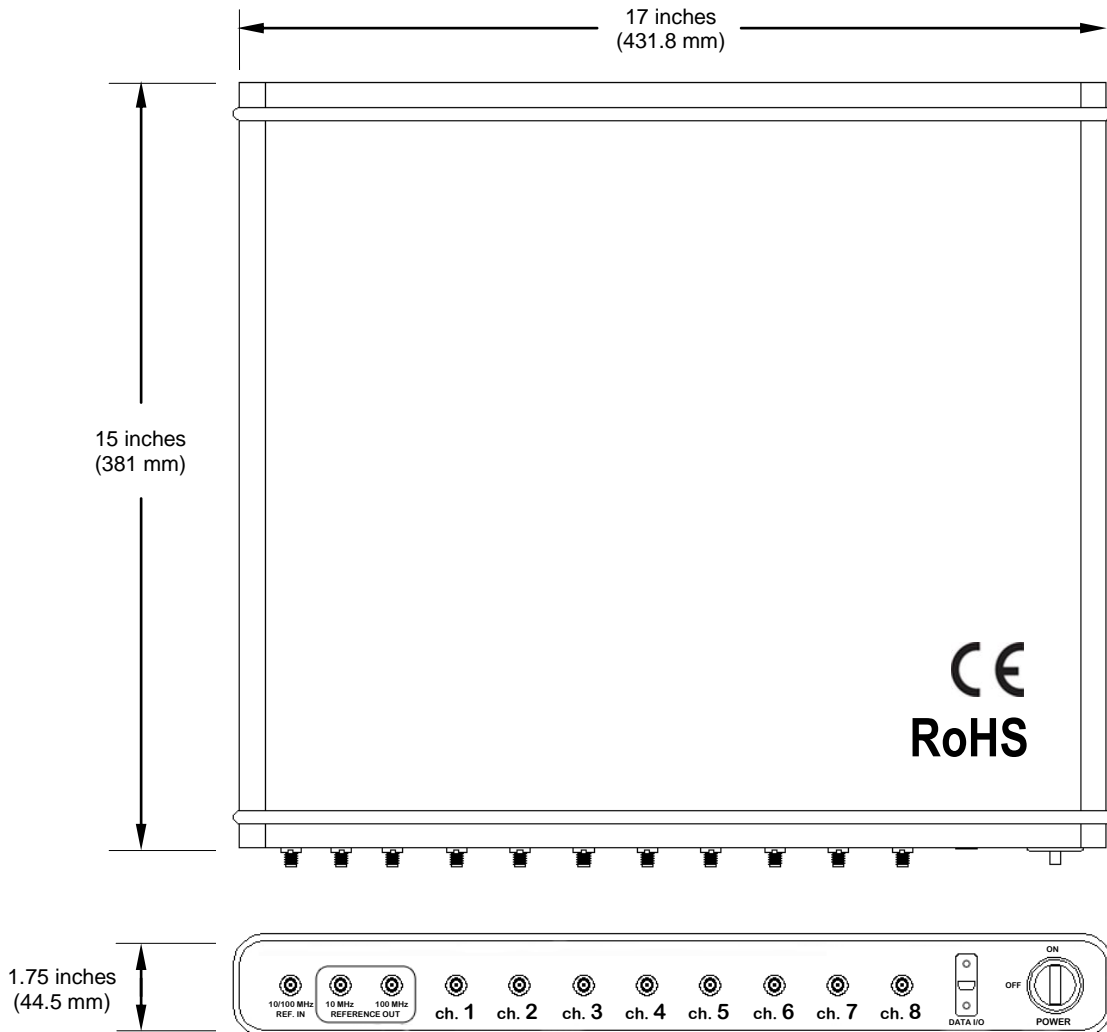

CONNECTORS and PHYSICAL SPECIFICATIONS

Front Panel	Description	Channel Output (1 – 8)	Ref.In (1), Ref. Out (2)	USB Data I/O (1)
	Type	SMA JACK	SMA JACK	Mini-B JACK
Rear Panel	Description	AC Input	OPT-ALTREF (3)	SPI Data I/O (1)
	Type	IEC 60320-1	SMA JACK	DB25 JACK
Physical Dimensions (L x W x H)		1U high, 19" rack mount: 15in x 17in x 1.75in (381mm x 431.8mm x 44.5mm)		
Weight		30 lb (13.6 kilograms) MAXIMUM		

VIRTUAL INSTRUMENT

Holzworth USB controlled Virtual Instruments have been designed to be as versatile as possible for integration into existing systems. Holzworth RF synthesizers can be controlled by the proprietary GUI application, LabVIEW™, MATLAB™, or any application capable of sending/receiving commands through a .DLL file.

Holzworth Synthesizers utilize the USB HID (Human Interface Device) transfer protocol. The HID protocol requires no installation of hardware drivers while providing the highest level of stability.

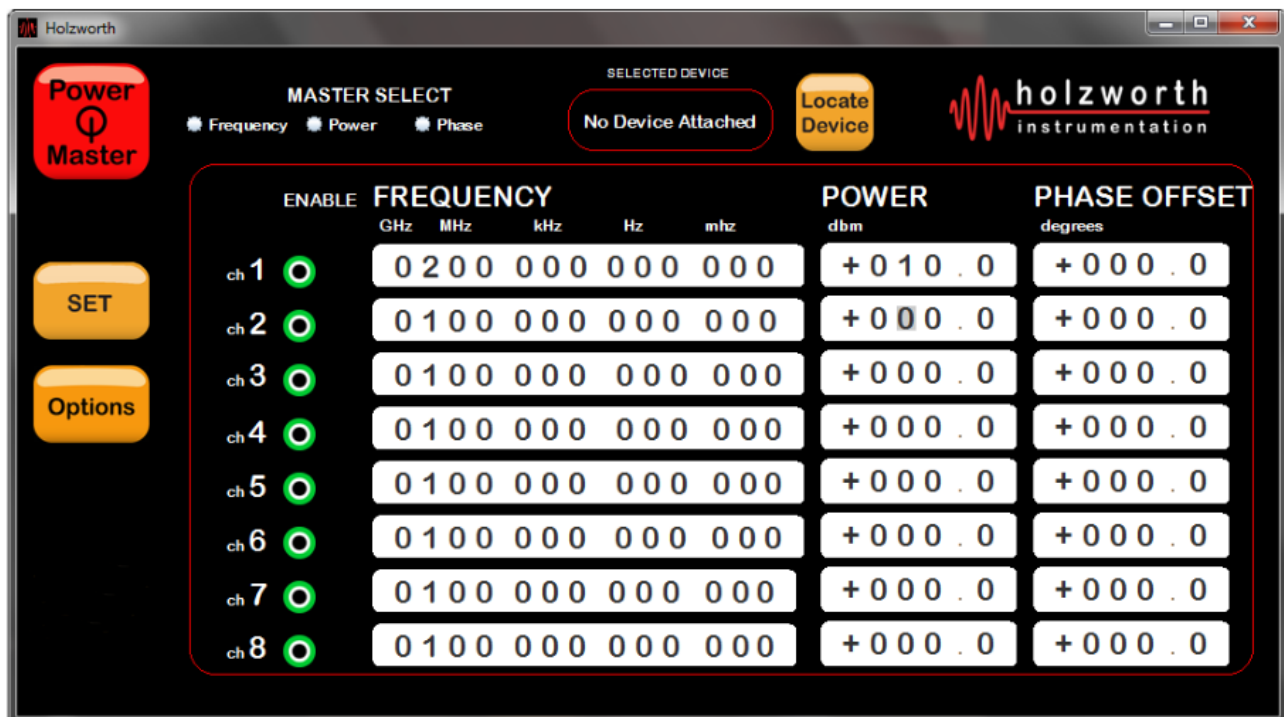

The provided GUI application is Java™ based. Java™ is an extremely robust platform and accepted as an industry standard. Operating on a minimal amount of memory (<2.0MB), users can run the application directly from a USB memory stick.

DLL access is also provided for "VISA", LabVIEW™, MATLAB™, etc. control over the instrument.

WARRANTY

All Holzworth synthesizers come with a 2 year 100% product warranty covering manufacturing defects. All product repairs and maintenance must be performed by Holzworth Instrumentation. Holzworth reserves the right to invalidate the warranty for any products that have been tampered with or used improperly. Refer to Holzworth Terms & Conditions of Sales for more details.

LEGACY PART NUMBER CROSS REFERENCE

Legacy part numbers can be ordered only under revision B. Otherwise, select the HS9000 Series equivalent from the cross reference matrix. Performance parameters for all revised part numbers will be identical to the equivalent HS9000 Series part.

Legacy Part Number	Description	Revised Part Number	HS9000 Series Part Number
HS1011A	1 channel, 1GHz RF Synthesizer (1U chassis)	HS1011B	HS9001A, OPT-A1
HS1002A	2 channel, 1GHz RF Synthesizer	HS1002B	HS9002A, OPT-A2
HS1004A	4 channel, 1GHz RF Synthesizer	HS1004B	HS9004A, OPT-A4
HS1008A	8 channel, 1GHz RF Synthesizer	HS1008B	HS9008A, OPT-A8
HS2011A	1 channel, 2GHz RF Synthesizer (1U chassis)	HS2011B	HS9001A, OPT-B1
HS2002A	2 channel, 2GHz RF Synthesizer	HS2002B	HS9002A, OPT-B2
HS2004A	4 channel, 2GHz RF Synthesizer	HS2004B	HS9004A, OPT-B4
HS2008A	8 channel, 2GHz RF Synthesizer	HS2008B	HS9008A, OPT-B8
HS3011A	1 channel, 3GHz RF Synthesizer (1U chassis)	HS3011B	HS9001A, OPT-C1
HS3002A	2 channel, 3GHz RF Synthesizer	HS3002B	HS9002A, OPT-C2
HS3004A	4 channel, 3GHz RF Synthesizer	HS3004B	HS9004A, OPT-C4
HS3008A	8 channel, 3GHz RF Synthesizer	HS3008B	HS9008A, OPT-C8
HS6011A	1 channel, 6GHz RF Synthesizer (1U chassis)	HS6011B	HS9001A, OPT-E1
HS6002A	2 channel, 6GHz RF Synthesizer	HS6002B	HS9002A, OPT-E2
HS6004A	4 channel, 6GHz RF Synthesizer	HS6004B	HS9004A, OPT-E4
HS6008A	8 channel, 6GHz RF Synthesizer	HS6008B	HS9008A, OPT-E8

QUESTIONS & PURCHASE INFORMATION

For additional product information, including quotations with lead times, please contact Holzworth Instrumentation or your local sales representative.

Holzworth Instrumentation Technical Support

Phone: +1.303.325.3473 (option 1)

Email: sales@holzworth.com

Holzworth Instrumentation Sales Support

Phone: +1.303.325.3473 (option 2)

Email: support@holzworth.com