

PRODUCT SUMMARY

The Holzworth HSM Series RF Synthesizer Modules are stand alone, CW sources. These sources are designed as building blocks for systems integration where performance at the foundation is critical. Holzworth synthesizers provide best in industry stability. When integrated as multiple units, the result is true phase coherency with industry leading channel-to-channel stability. Compare the HSM Series to competitive designs and discover the most compact form factor available in its overall performance class.



The core architecture of the HSM Series modules is derived from Holzworth’s proprietary NON-PLL design to provide the ultimate in phase / frequency stability. This direct-digital/direct-analog hybrid design was originally developed as a key building block for our phase noise analysis products. The hybrid architecture provides frequency agility & resolution, phase continuous switching and predictable performance without compromising on spurious or phase noise performance.

HSM EXTENDED FREQUENCY OPTIONS:

Model No.	Frequency Range	Phase Noise Performance
HSM1001A	250kHz to 1GHz	-134dBc/Hz ^{1/2} at 1GHz (10kHz offset)
HSM2001A	250kHz to 2GHz	-128dBc/Hz ^{1/2} at 2GHz (10kHz offset)
HSM3001A	250kHz to 3GHz	-123dBc/Hz ^{1/2} at 3GHz (10kHz offset)
HSM4001A	250kHz to 4GHz	-122dBc/Hz ^{1/2} at 4GHz (10kHz offset)
HSM6001A	250kHz to 6.7GHz	-118dBc/Hz ^{1/2} at 6GHz (10kHz offset)

Note: Holzworth’s “Ultra Low Phase Noise” statement is real. We make no assumptions. 100% of all RF synthesizers manufactured by Holzworth Instrumentation are subjected to full phase noise evaluation. This critical parameter cannot be accepted as being “OK” based on spectrum analysis or an alternate test.

The versatile HSM Synthesizer Modules can be controlled directly via the SPI bus, the Holzworth GUI, a preloaded lookup table, LabVIEW™, MATLAB™, C++, C#, etc. Some systems integrators have preferred the supported Linux platform over a window based PC. An advanced application example uses a preloaded lookup table in a multi-channel configuration further leveraging the unique NON-PLL characteristics to achieve switching speeds of <100ns with phase memory.

The attractive performance-to-price ratios available with the Holzworth HSM Series offer optimal solutions for electronics design, manufacturing test applications, and OEM systems integration.

Finally, with MTBFs approaching 200,000 hours, the HSM Series synthesizer modules have been designed to exceed the most stringent reliability requirements.

HSM DESIGN HIGHLIGHTS

- Amplitude Accuracy ±0.25dB (typ) to -80dBm
- Switching Speed: <10µS, 100% settled
- Pulse Modulation Burst Mode (internal pulse)
- Onboard Precision 100MHz OCXO
- 100MHz Reference Out: -165dBc/Hz^{1/2} (10kHz OS)
- Reference Input: 10MHz or 100MHz
- SPI or USB Communications Interface
- Internal Temperature Monitor Output

ELECTRICAL SPECIFICATIONS - FREQUENCY

The specified parameters for the HSM Series RF Synthesizer Modules are fully verified at final performance test and 100% guaranteed for the warranted life of the product. Performance specifications listed on this page are specific to Frequency.

FREQUENCY PERFORMANCE¹

PARAMETER	MIN	TYPICAL	MAX	COMMENTS
Frequency Range Model HSM1001A Model HSM2001A Model HSM3001A Model HSM4001A Model HSM6001A	250 kHz 250 kHz 250 kHz 250 kHz 250 kHz		1.024 GHz 2.048 GHz 3.072 GHz 4.096 GHz 6.720 GHz	All models settable down to 100kHz
Frequency Resolution	0.001 Hz			
Phase Offset Resolution 250 kHz – 512 MHz 512 MHz – 1.024 GHz 1.024 GHz – 2.048 GHz 2.048 GHz – 4.096 GHz 4.096 GHz – 6.528 GHz		0.1 deg 0.2 deg 0.4 deg 0.8 deg 1.6 deg		Offset Accuracy: ±0.05 deg ±0.10 deg ±0.20 deg ±0.40 deg ±0.80 deg
Switching Speed (Frequency) SPI Mode (ASCII) SPI Mode (Binary) List/Step Sweep Mode (WB) List/Step Sweep Mode (NB)			300 µs 100 µs 100 µs 6 µs	Wideband Steps (full bandwidth) Narrowband Steps (<5% bandwidth)
Internal Time Base Reference (Oscillator Aging Rate)		□	± 1 ppm/yr	1 st year. ±0.5 ppm/yr each subsequent year
Temperature Effects		± 1 ppm		0 to 55 °C
Line Voltage Effects (12V)		± 0.1 ppm		• ±5%
Reference Output Frequency Amplitude Impedance	+2 dBm	100MHz 50 Ω	+6 dBm	Nominal Nominal
External Reference Input Input Frequency 10MHz Lock Range 10MHz External Amplitude 100MHz External Amplitude Impedance Waveform	0 dBm +2 dBm	10 / 100 ± 4 ppm 50 Ω	± 1 ppm +10 dBm +6 dBm	Software Select 10MHz, 100MHz or No Ext. Ref. 20Hz Locking BW, Internal OCXO remains on 20Hz Locking BW, Internal OCXO remains on Internal OCXO shuts off 50 Ω (nom) Sine
Digital Sweep Modes Operating Modes Sweep Range Dwell Time Number of Points (STEP) Number of Points (LIST) Triggering	250 kHz 100 µs 2 2		6.528 GHz 100 s 65535 3201	Step sweep (linear, internal) List Sweep (arbitrary list of freq steps) Simultaneous Amplitude sweep (list) 1 µs increments Free Run, External Trigger

¹ Specifications are subject to change per the discretion of Holzworth Instrumentation, Inc

ELECTRICAL SPECIFICATIONS - AMPLITUDE

The specified parameters for the HSM Series RF Synthesizer Modules are fully verified at final performance test and 100% guaranteed for the warranted life of the product. Performance specifications listed on this page are specific to Amplitude.

AMPLITUDE PERFORMANCE¹

PARAMETER	MIN	TYPICAL	MAX	COMMENTS
Output Power (Calibrated)	-80 dBm		+10 dBm	Settable to +13dBm
Resolution			0.01 dB	
Step Attenuator	0 dB		100 dB	5 dB steps
Connector		50 Ω		SMA
SWR				
<100 MHz		1.7:1		
< 2.048 GHz		1.4:1		
< 3.072 GHz		1.5:1		
< 6.528 GHz		2.0:1		
Maximum Reverse Power				
Max DC Voltage			25 VDC	
250 kHz to 6.528 GHz			10 mW	10dBm
Switching Speed (Amplitude)				
SPI Mode			300 μs	
List / Step Sweep Mode			100 μs	Settling to within 0.1 dB
Absolute Level Accuracy				
>+10dBm		+0.15 /-0.5 dB	+0.5 /-1.0dB	
+10 to -30dBm		±0.15 dB	±0.5 dB	
-30 to -70dBm (<4GHz)		±0.25 dB	±0.8 dB	
-30 to -60dBm (>4GHz)		±0.25 dB	±0.8 dB	25C to 35C (case temperature)
SSB Phase Noise				
100 MHz, 10kHz offset		≤ -150 dBc/Hz		≤ -151 dBc/Hz @ 20kHz offset
500 MHz, 10kHz offset		≤ -139 dBc/Hz		≤ -140 dBc/Hz @ 20kHz offset
1.0 GHz, 10kHz offset		≤ -134 dBc/Hz		≤ -135 dBc/Hz @ 20kHz offset
2.0 GHz, 10kHz offset		≤ -128 dBc/Hz		≤ -129 dBc/Hz @ 20kHz offset
3.0 GHz, 10kHz offset		≤ -123 dBc/Hz		≤ -124 dBc/Hz @ 20kHz offset
4.0 GHz, 10kHz offset		≤ -122 dBc/Hz		≤ -123 dBc/Hz @ 20kHz offset
6.0 GHz, 10kHz offset		≤ -118 dBc/Hz		≤ -119 dBc/Hz @ 20kHz offset
Harmonics (CW mode)				
Pout = 0dBm		-40 dBc	-30 dBc	
Pout = +10dBm		-30 dBc	-20 dBc	
Non-Harmonics (CW mode)				
250 kHz to 3.072 GHz		-70 dBc	-60 dBc	
3.072 GHz to 6.528 GHz		-60 dBc	-50 dBc	
Sub-Harmonics (CW mode)				
250 kHz to 3.072 GHz		-70 dBc	-60 dBc	
3.072 GHz to 6.528 GHz		-60 dBc	-50dBc	
Jitter				
155 MHz		60 fs		100Hz < BW < 1.5MHz
622 MHz		61 fs		1kHz < BW < 5MHz
2.488 GHz		55 fs		5kHz < BW < 20MHz

¹ Specifications are subject to change per the discretion of Holzworth Instrumentation, Inc

ELECTRICAL SPECIFICATIONS - MODULATION (External Stimulus)

The modulation parameters listed here are based on modulation functions as related to the use of an external modulation stimulus. Internal “self pulse” functions are available with the current revision of the HSM series RF synthesizers (to be specified).

PARAMETER	PERFORMANCE	COMMENTS
FREQUENCY MODULATION¹ (Analog)		
Max Deviation	100 kHz	
Resolution	0.01% or 1mHz, whichever is greater	
Deviation Accuracy	< ± 2%	
Modulation Freq. Response	DC to 20 kHz (-3dB)	DC Coupled
Distortion	TBD	
Sensitivity when using Ext. Input	± 1V peak into 50Ω	+ 1V: Maximum Positive Deviation 0V: Zero Deviation from Carrier - 1V: Maximum Negative Deviation
PHASE MODULATION¹ (Analog)		
Modulation Deviation	±1.6 deg to ±180 deg	
Frequency Response	DC to 20 kHz (-3dB)	DC Coupled
Resolution	Frequency Dependent	See Phase Offset Specification
Distortion	TBD	
Sensitivity when using Ext. Input	± 1V peak into 50Ω	+ 1V: Maximum Positive Deviation 0V: Zero Deviation from Carrier - 1V: Maximum Negative Deviation
AMPLITUDE MODULATION¹ (Analog)		
AM Depth Type	Linear	
Depth		
Maximum	5% to 75%	0.45 dB to 12 dB
Resolution	<3% of Maximum Depth	
Depth Accuracy	5% of Maximum Depth	
Modulation Rate	DC to 10 kHz (-3dB)	DC Coupled
Distortion	TBD	
Sensitivity when using Ext. Input	± 1V peak for indicated Depth (into 50Ω)	+ 1V: Maximum Amplitude 0V: 50% of Maximum Depth - 1V: Maximum Depth
PULSE MODULATION¹ (Analog)		
Risetime (T _r)	<100 ns	
Falltime (T _f)	<100 ns	
On/Off Ratio	> 70dB	
Minimum Pulse Width	200 ns	
ALC Loop Deviation (Open Loop) ²	1dB ²	

¹ Specifications are subject to change per the discretion of Holzworth Instrumentation, Inc

² ALC Loop is disabled during pulse modulation

PARAMETER	PERFORMANCE	COMMENTS
External Trigger Threshold	+1.2V	±5% into 50Ω

ENVIRONMENTAL SPECIFICATIONS ¹

Environmental specifications are based on component margins, thermal verification testing and current draw tests.

PARAMETER	MIN	TYPICAL	MAX	COMMENTS
Operating Temperature				
Standard Models	0 C		+55 C	Performance tests at: +20C ±5C
Option: OPT-SYS1	-40 C		+75 C	Performance tests at: -40, 0, +20, +75C ±2C
Option: OPT-SYS2	0 C		+55 C	Performance tests at: +20C ±5C
Temperature Monitor Range	-40 C		+85 C	Absolute
Power Consumption²				
Standard Models		9 W	12 W	12W during warm-up (OCXO)
Option: OPT-SYS1		7 W		No OCXO
Option: OPT-SYS2		7 W		No OCXO
Warm-Up Time		5 min	10 min	20 C (ambient temp. dependent)

¹ Specifications are subject to change per the discretion of Holzworth Instrumentation, Inc

² See PINOUT CONFIGURATION table on page 10 for volt/amp ratings per pin.

PHASE NOISE DATA

The raw data displayed in Figure 1 is of SSB Phase Noise vs. Frequency Offset as measured for the HSM Series RF Synthesizer Modules. All data was collected at an output power setting of +10dBm.

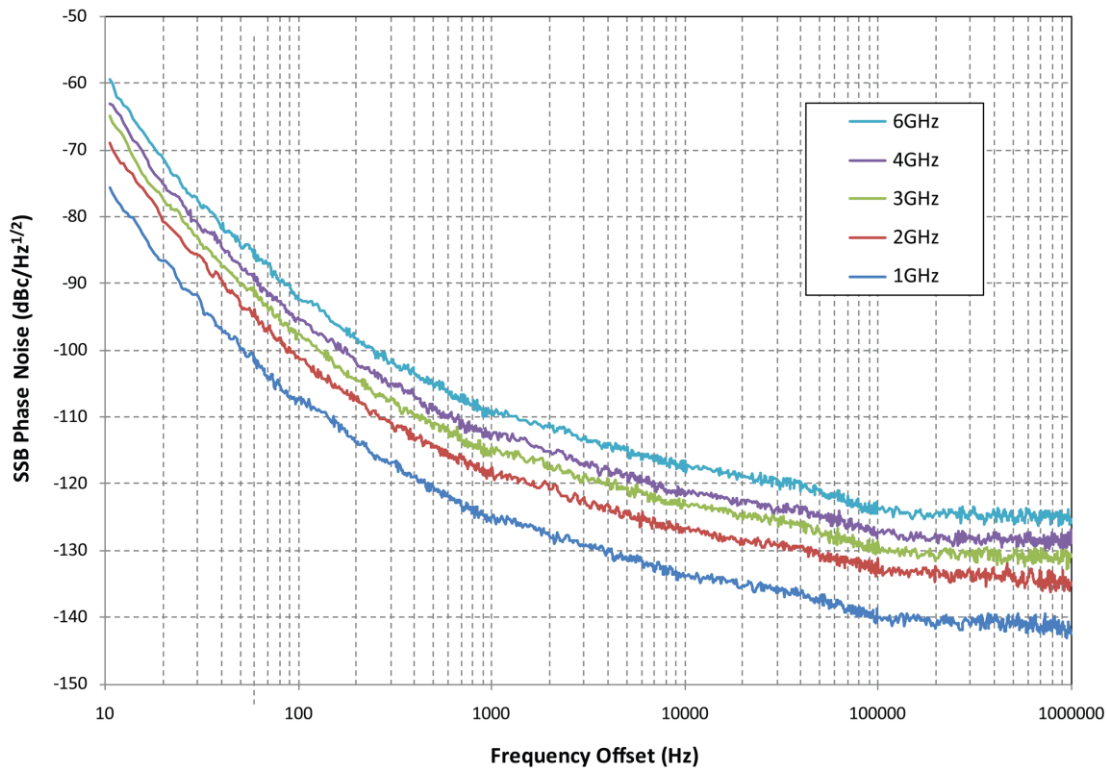

Figure 1: SSB Phase Noise (P_{OUT}=+10dBm)

SPECTRAL PURITY DATA

The data contained in this section demonstrates the spectral purity performance of the HSM Series designs. All measurements are made at Pout = +10dBm to demonstrate worst case performance. Spectrum analyzer settings for all measurements were: 100kHz Resolution BW, 10kHz Video BW.

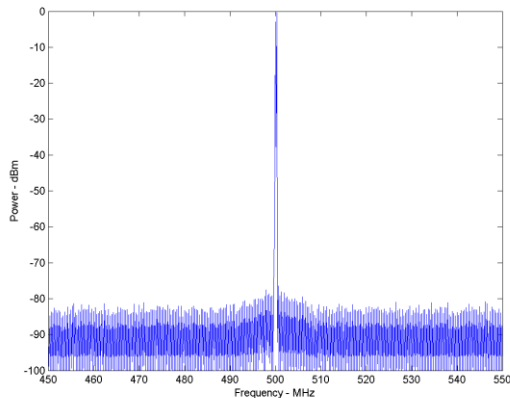

Figure 2a: 500MHz Narrow Band Spectrum

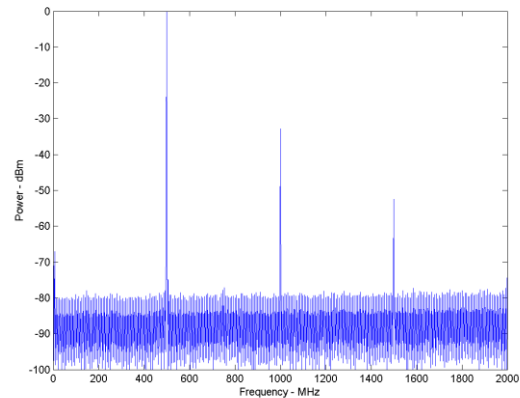

Figure 2b: 500MHz Broad Band Spectrum

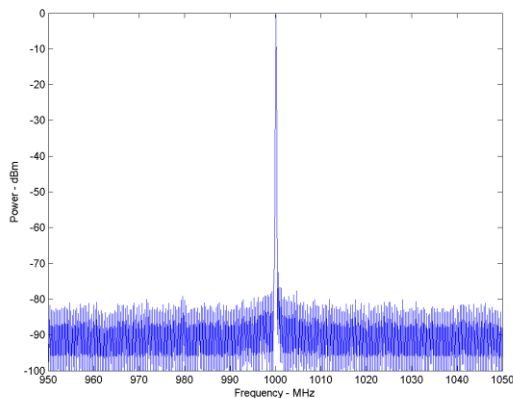

Figure 3a: 1GHz Narrow Band Spectrum

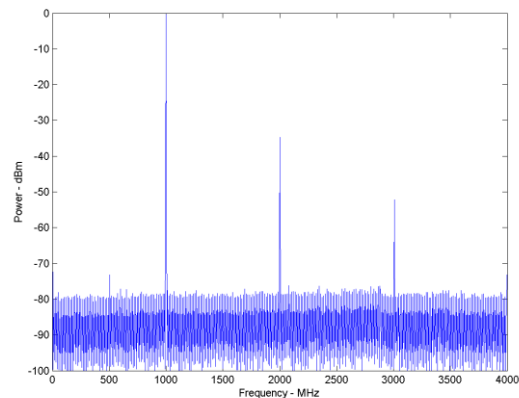

Figure 3b: 1GHz Broad Band Spectrum

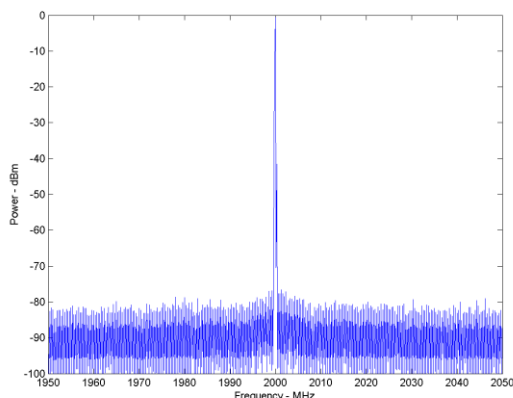

Figure 4a: 2GHz Narrow Band Spectrum

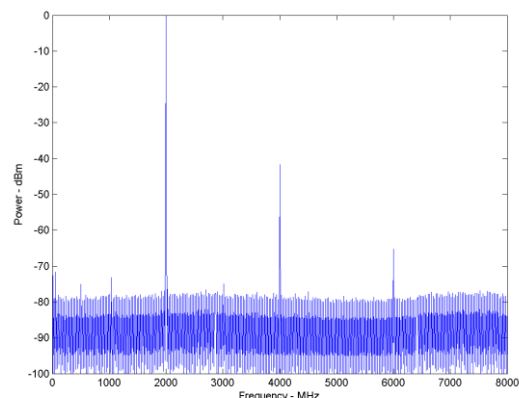

Figure 4b: 2GHz Broad Band Spectrum

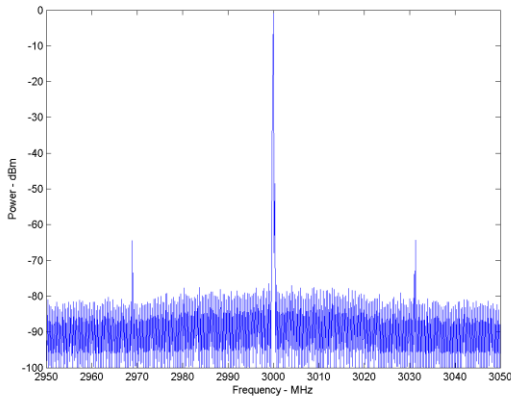

Figure 5a: 3GHz Narrow Band Spectrum

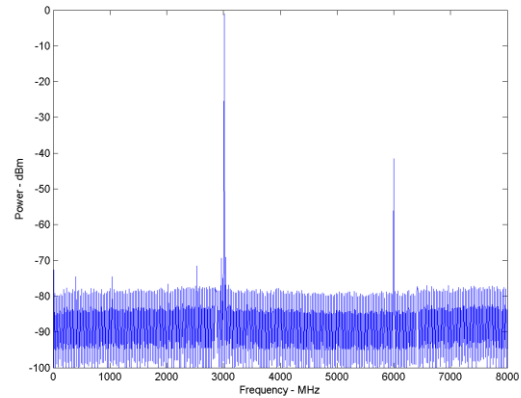

Figure 5b: 3GHz Broad Band Spectrum

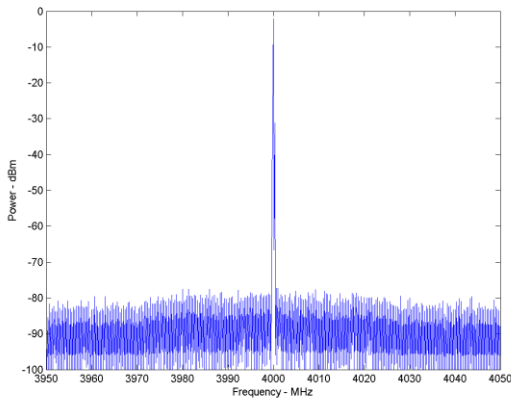

Figure 6a: 4GHz Narrow Band Spectrum

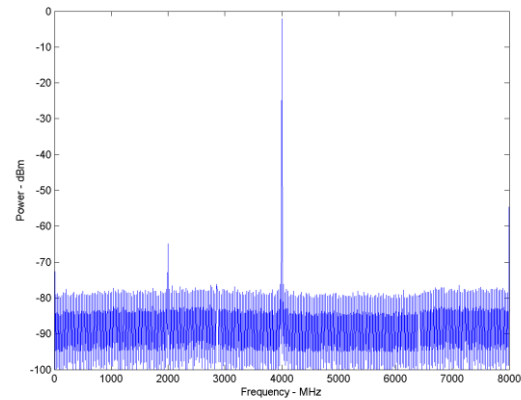

Figure 6b: 4GHz Broad Band Spectrum

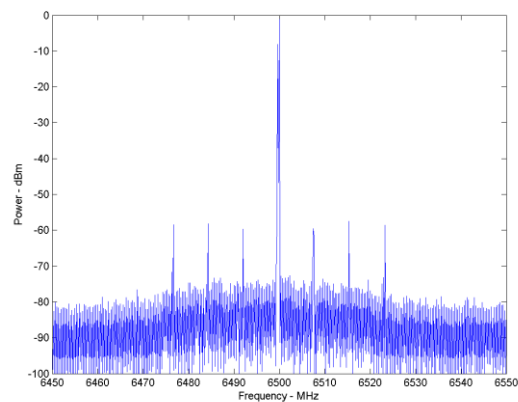

Figure 7a: 6.5GHz Narrow Band Spectrum

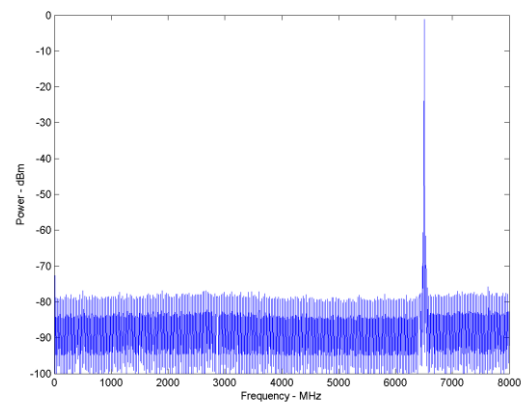
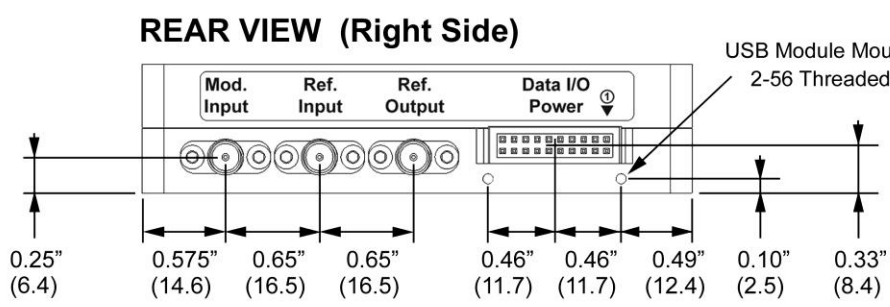
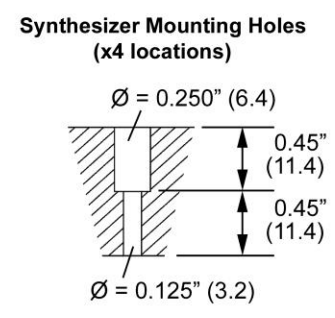
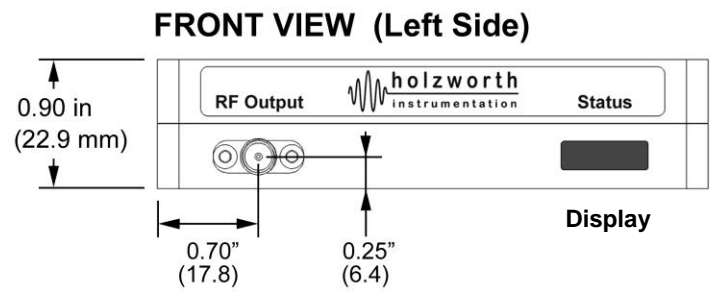
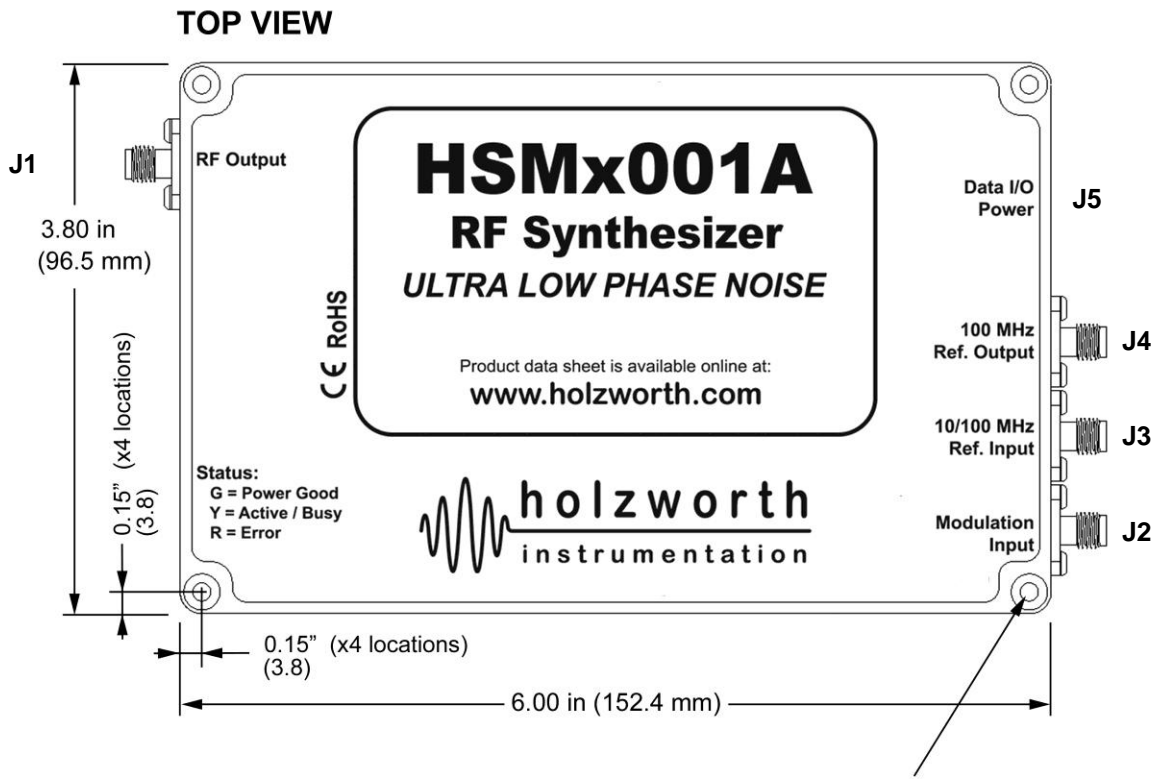

Figure 7b: 6.5GHz Broad Band Spectrum

Data at additional frequencies available upon request.

MECHANICAL CONFIGURATION (Standard)

Mechanical details are in both inches and millimeters (listed inside parenthesis). All dimensions hold tolerances to within ±0.005 inches.



MECHANICAL CONFIGURATION - OPTIONS: OPT-SYS1 / OPT-SYS2

Option "OPT-SYS1" & "OPT-SYS2" do not contain an OCXO, allowing for an extended operating temperature range and smaller form factor. An external 100MHz reference is required. OPT-SYS1 units are performance tested over full specified temperature range. Mechanical details are in both inches and millimeters (listed inside parenthesis). All dimensional tolerances are within ± 0.005 in.

TOP VIEW

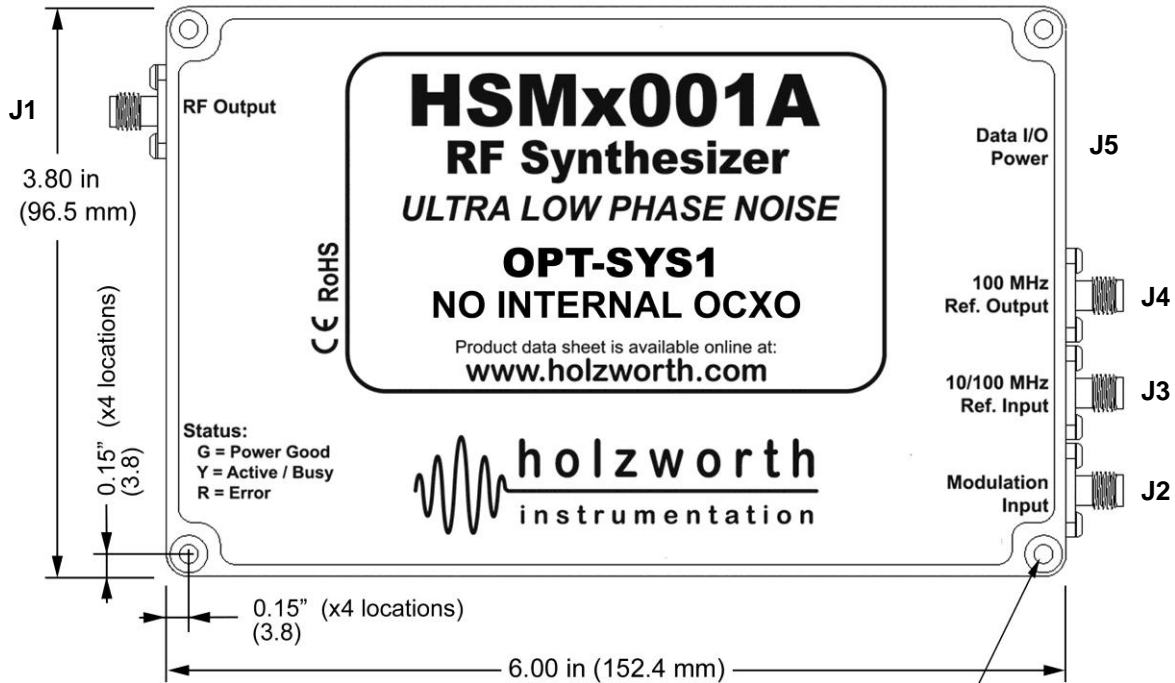

FRONT VIEW (Left Side)

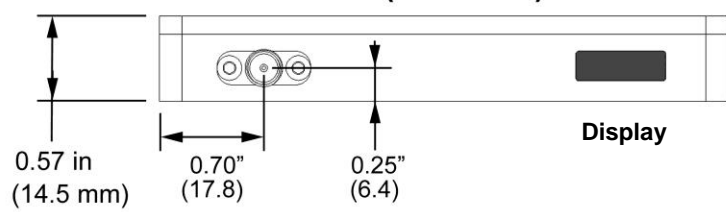

Synthesizer Mounting Holes (x4 locations)

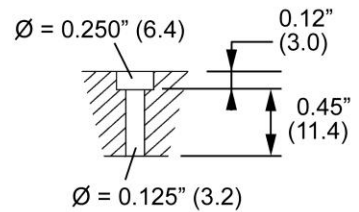

REAR VIEW (Right Side)

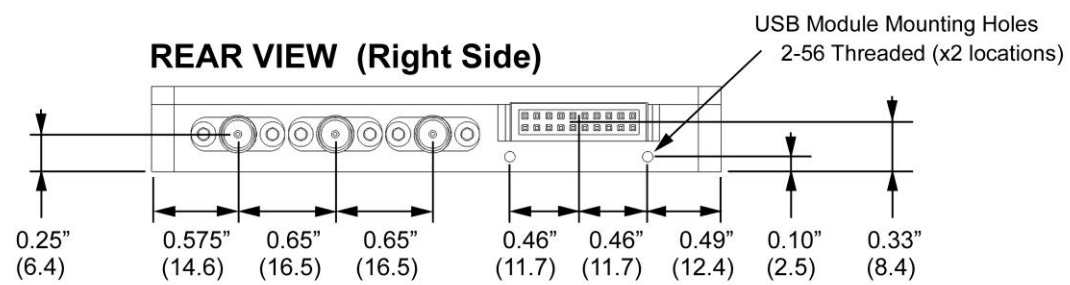

INTERFACE DEFINITIONS

The interfaces defined within this section are cross referenced to the mechanical configuration included in this document. Ports are labeled on the synthesizer modules, but numbers are not physically printed on the module.

J-PORT DEFINITIONS

PORT	LABEL	DESCRIPTION
J1	RF Output	SMA Jack
J2	Modulation Input	SMA Jack, Multiplexed, 50ohm Input <ul style="list-style-type: none"> • Frequency Modulation: ± 1 V Analog Input • Amplitude Modulation: 0 to 1 V Analog Input • Phase Modulation: ± 1 V Analog Input • Trigger/Pulse mod: 1.2 V Threshold
J3	10/100 MHz Ref. Input	SMA Jack: 10MHz/100MHz Reference Input (software selectable) <ul style="list-style-type: none"> • 10MHz: 0dBm to +10dBm Input (PLL Lock Range: ± 1ppm) • 100MHz: +4 dBm out, ± 2 dB Input (Internal OCXO is shut off)
J4	100MHz Ref. Output	SMA Jack: 100MHz Reference Output <ul style="list-style-type: none"> • 100MHz: +4 dBm out, ± 2 dB (nom)
J5	Data I/O - Power	2mm, 20pin (2x10) Milli-grid Shrouded Pin Header (detent type) Contains Power, Ground, SPI and Status Indicators
Display	Status	Tri-color LED Indicator Panel: GREEN = Power Good YELLOW = Communication Active / Busy / Not Ready RED = ERROR (i.e. no 10MHz PLL lock, Unleveled, etc.)

PINOUT CONFIGURATION

PIN No.	Label	PIN No.	Label
1	GND	2	GND
3	+ 5V, 1A (max)	4	+5V tied to pin 3
5	+12V , 400mA (nom), 600mA (warm-up) ¹	6	N.C. (reserved)
7	NC	8	N.C. (reserved)
9	/RESET (10k PU to 3.3V)	10	N.C. (reserved)
11	/CS (Module Select)	12	Trigger (5V Tolerant Input)
13	SDO (Module Data Output)	14	PowerGood (OC – 47k PU to 3.3V)
15	SDI (Module Data Input)	16	/ERROR (OC – 47k PU to 3.3V)
17	SCLK (Module Clock Input)	18	/BUSY (OC – 47k PU to 3.3V)
19	GND	20	GND

¹ Pin 5 +12V at 175mA for OPT-SYS1 and OPT-SYS2. No onboard OCXO.

J5 PIN LABEL DEFINITIONS

PIN Label	DEFINITION
+5V	Nominally pulls 1A from the +5V Rail. Initially at power on the draw will be 100mA then increase as subsystems power-on. Tolerance +10% to -2%. 4.9V to 5.5V.
+12V [or +15V]	Nominally 400mA draw at steady state. 600mA draw at startup for at least 5 mins for OCXO power on. +15V O.K. but increases power dissipation. Units without OCXO will draw constant 175mA (OPPT-SYS1 & OPT-SYS2).
NC	No Connect. Voltage supply pin. Not currently used.
/RESET	Active low on this pin put the module in reset, releasing it returns to reset operation. Module is ready 1-2 seconds after /RESET is released. 10K pullup to 3.3V in parallel to 0.01uF cap to ground.
/CS	Communications chip select, active low. 47K pullup on this line. /CS must be low for any communication to occur. Allows for multiple synthesizer modules on 1 spi bus. 3.3V logic levels, 5V tolerant.
MSDI	Master Serial Data Input (synthesizer module/slave data out). Active when chip select is low. High-Z when /CS is high. 47K pulldown. 3.3V logic levels, 5V tolerant.
MSDO	Master Serial Data Output (synthesizer module/slave data in). High-Z input on module. 3.3V logic levels, 5V tolerant. 47K pulldown.
SCLK	SPI Clock (slave clock input). Idle Low, Active High. Data is transitioned into the module on a rising low to high transition. Data is transitioned out on the same edge and is valid on the falling edge of SCLK. 3.3V logic levels, 5V tolerant. 47K pulldown.
TRIGGER	CMOS Trigger input to the onboard microprocessor
Power Good	Open collector output, 47k pullup to 3.3V. When high, power is healthy. When low, either voltages or currents are problematic. Module may not operate correctly. There is a 0.5 second delay from when power is applied to a valid PowerGood. Actual PowerGood may take up to 2 seconds to go high due to some very stable internal references that are settling. This may be multiplexed with other HSM6001 synthesizers.
/ERROR	Open collector output, 47k pullup to 3.3V. Nominally high. If an error condition occurs, such as a PLL unlock or un-leveled condition, this will go active low. This can be multiplexed with other HSM6001 synthesizers.
READY or /BUSY	Open collector output, 47k pullup to 3.3V. Nominally high. After an SPI communication, if a command has been issued, then the /BUSY will go active low until that command is finished. During this time no communication may occur and SPI bus will be asleep.
N.C.	These are reserved lines for use in our communications module. They should be left floating.

J5 (SPI) MATING CONNECTOR PART NUMBERS

APPLICATION	MOLEX PART NUMBER	DESCRIPTION
IDC Ribbon	Molex 87568-2093	2mm Milli-Grid, 20pin (2x10) Female, Polarization and Ramp Locking
Vertical PCB Thru Hole	Molex 79107-7009	2mm Milli-Grid, 20pin (2x10) Female, NO Polarization or Ramp Locking
Vertical PCB SMT	Molex 79109-1009	2mm Milli-Grid, 20pin (2x10) Female, NO Polarization or Ramp Locking

SPI COMMUNICATIONS
BUS OVERVIEW

The SPI bus is a byte oriented bus, sending 8bits at a time. Any number of bytes may be sent, from 1 byte to 64 bytes while chip select is low. Bytes sent beyond 64 bytes will be ignored. The data is held in a buffer until chip select goes high, initiating the parsing of the data and execution of the commands. The maximum speed of the bus is 10Mbps/s. Data may be written to the module and data may be received from the module. After a command is sent requesting data, the next transfer sends this data out on SDO. During the read, a new command may be send and will be parsed when chip select goes high. A read is always followed by a write with a read request.

BUS HARDWARE PROTOCOL

Data is clocked into the module on the rising edge of sclk. Data is clocked out of the module on this same edge. Data output is valid on the falling edge of sclk. Data is only transferred when chip select is low. When chip select goes high, this initiates the parsing and execution of data.

CONTROLLING MULTIPLE SYNTHESIZERS

The SPI bus may be daisy chained. The Status flags can be daisy chained as well, they are open-collector. Each synthesizer requires it's own chip select in a multiple channel scenario.

SPI TIMING

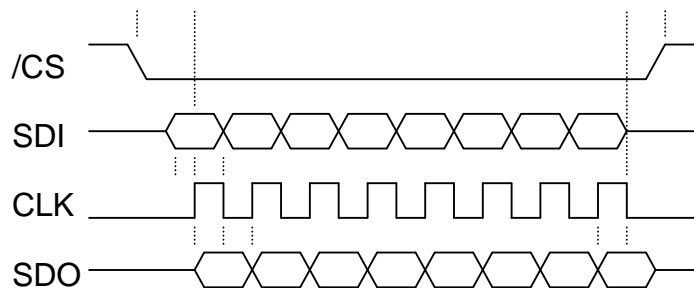

The figure above demonstrates bit level timing where data is sampled into and out of the module on the rising edge of SCLK (Slave Clock). Data out is valid on the falling edge of SCLK.

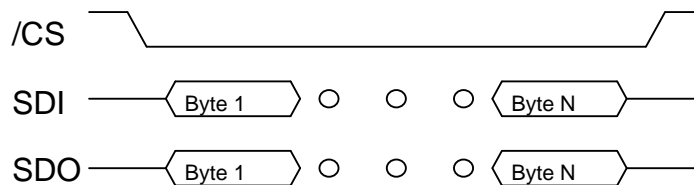

The above figure displays how byte level communications occurs. Any number of bytes may be sent. After /CS goes high, the data is parsed and executed. If no data is sent, the SPI communications module simply resets itself and no parsing or execution of data occurs. If /CS goes high in the middle of a byte transfer (1-7 bits are sent instead of 8) this byte is ignored.

WARRANTY

All Holzworth synthesizers come with a standard 2 year 100% product warranty covering manufacturing defects. All product repairs and maintenance must be performed by Holzworth Instrumentation. Holzworth reserves the right to invalidate the warranty for any products that have been tampered with or used improperly. Refer to Holzworth Terms & Conditions of Sales for more details.

OPTIONS

Holzworth HSM series RF synthesizers have options to assist with better meeting specific systems requirements.

OPT-OCXO	10dB Improved Close to the Carrier Phase Noise
OPT-SYS1	14mm Profile (no OCXO), Tested over extended Temp. Range
OPT-SYS2	14mm Profile (no OCXO), Tested over standard Temp. Range

Communications modules are also made available for ease of integration or simply to match legacy laboratory communications requirements. USB, Ethernet, GPIB, *etc.* modules can be purchased directly from Holzworth.

HCM1: USB Communications Module

Model HCM1 is basically an SPI to USB and power adapter that allows the user to connect the RF synthesizer to standard AC power, in addition to making a standard USB connection to PC so that the Holzworth GUI, LabVIEW™, MATLAB™, *etc.* can be utilized to control the source. No drivers are required to run the Holzworth GUI.

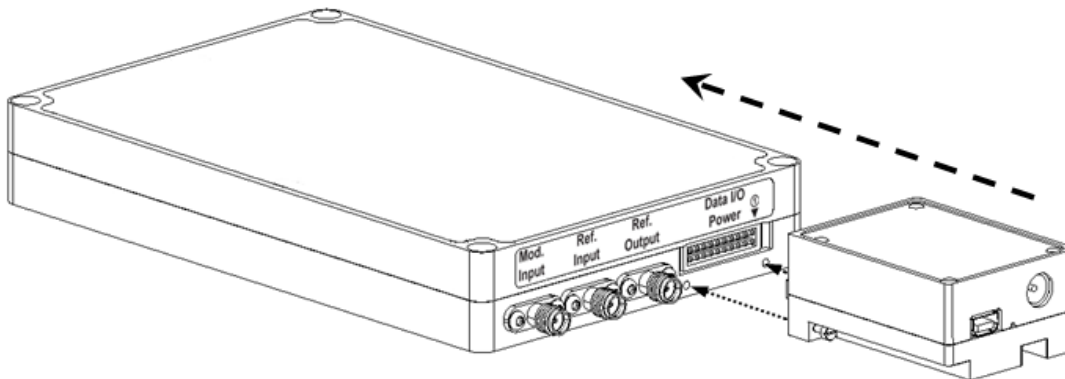

The USB Communications Module securely fastens to the synthesizer and comes complete with an AC power supply and USB cable. It is a recommended accessory as the first step in integrating the units via the SPI bus. More information is available upon request.